

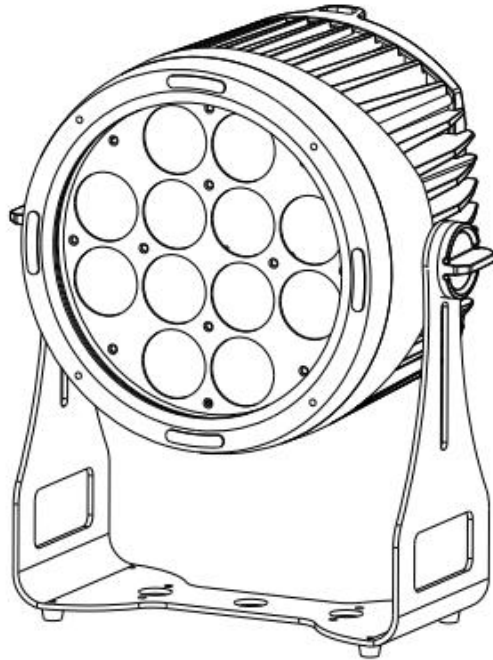

EASY - PL1215

LED Outdoor Par 12x15w RGBWA UV



This product manual contains important information about the safe installation and use of this projector. Please read and follow these instructions carefully and keep this manual in a safe place for future reference.

User manual

Please read the instructions carefully before use

ABLE` OF CONTENTS

- 1. Dimension.....3
- 2. Safety Information3
- 3. Configuring the fixture 4
- 4. Connecting to a DMX control device 4
- 5. Configuring the fixture for DMX control5
- 6. Cleaning 6
- 7. DMX Channel6
- 8. Control menu 7
- 9. Specification 11
- 10. Photometrics 12
- 11. Reminder 12

STATEMENT

The product has well capability and intact packing when leave factory. All of the user should comply with warning item and manual, any misuse cause of the damages are not included in our guarantee, and also can not be responsible for any malfunction & problem owing to ignore the manual.

1. Dimension

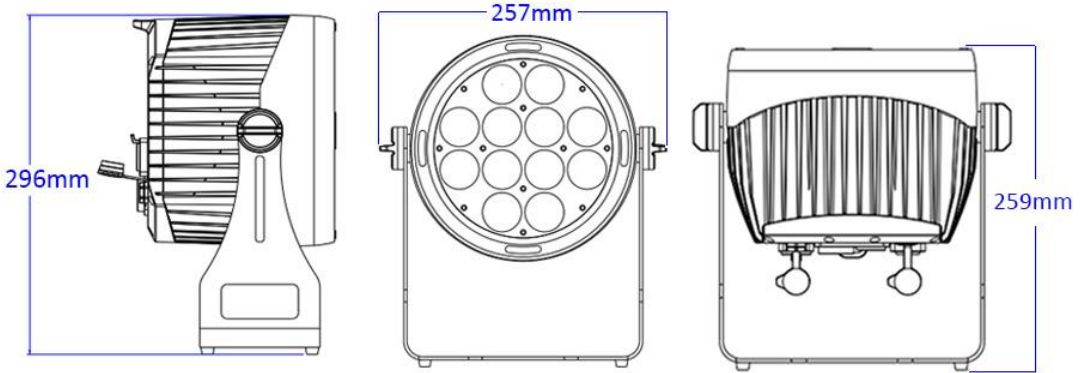

2. Safety Information



WARNING! Read the safety precautions in this section before unpacking, installing, powering or operating this product.

This luminaries are multi-environmental fixtures with an IP-rating of 65, intended for professional use only. They are not suitable for household use.

Review the following safety precautions carefully before installing or operating the fixture. This fixture must be installed in accordance with the applicable installation code by a person familiar with the construction and operation of the fixture and the hazards involved.

Preventing electric shock



WARNING! Risk of electric shock.

- Always power off/unplug the fixture before removing any covers.
- Ensure that the power is turned off when connecting the fixture to the AC mains supply.
- Ensure that the fixture is electrically connected to earth (ground).
- Do not apply power if the fixture is in any way damaged.
- Do not immerse the fixture in water or liquid.

3. Configuring the fixture

Set up the fixture using the control panel and OLED display at the base of the fixture.

Navigate the menus and options using the arrow buttons and select items using the Enter button. The options available are listed in “Control menu” on page 9.

After powering on, the display shows the currently selected operating mode and other information.

The fixture is set by default to be controlled in DMX mode.

4. Connecting to a DMX control device

The fixture is controllable using a DMX control device and it can be connected using a DMX cable.

If using a cabled DMX system, connect the DMX in cable (with male 5-pin XLR plug) and out cable (with female 5-pin XLR plug) to the DMX data link. Terminate the DMX out cable of the last fixture in the data link. For outdoor installations, use only IP-rated XLR connectors suitable for outdoor use.

The DMX512 is widely used in intelligent lighting control, with a DMX 512 controller. connect several lights together, dmx in and dmx out, 5 pin XLR connectors

**DMX - INPUT
XLR plug**



Pin1 : GND - Shield
Pin2 : - Signal
Pin3 : + Signal
Pin4 : N/C
Pin5 : N/C

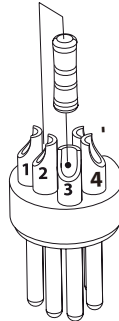

**DMX - OUTPUT
XLR socket**

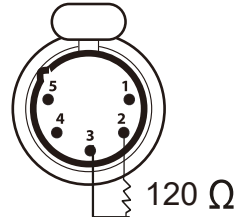

5. Configuring the fixture for DMX control

About DMX

The fixture can be controlled using signals sent by a DMX controller on a number of channels (which varies depending on the DMX mode that has been set).

The first channel used to receive data from a DMX control device is known as the DMX start address. Each fixture must have a DMX start address set. For example, if a fixture has a DMX address of 10 and it is in 4-channel DMX mode, then it uses channels 10, 11, 12 and 13. The following fixture in the DMX chain could then be set to a DMX address of 14. If two or more DMX fixtures of the same type have the same DMX address, then they will mimic each other's behaviour. Incorrect settings will result in unpredictable responses to the lighting controller.

Setting the DMX address

The DMX address can be seen on the main screen. To change the address setting, press the up arrow to increase the address, or the down arrow to decrease the setting. When the desired address is displayed, press Enter to save the setting.

Note that channel spacing is determined by the DMX mode. See the “DMX protocols” on page 7 for specific DMX control values.

Setting the DMX mode

Using the “DMX mode” menu available from the control panel, specify the DMX mode that provides the fixture controls that you require, confirm chosen mode by pressing ‘Enter’.

6. Cleaning

To maintain optimal performance, regular cleaning is essential. Cleaning schedules will vary depending on the operating environment, and the installation should therefore be checked at frequent intervals within the first few weeks of operation to see whether cleaning is necessary. This procedure will allow you to assess cleaning requirements in your particular situation. Clean the fixture using a soft cloth dampened with a solution of water and a mild detergent. Do not use products that contain solvents, abrasives or caustic agents for cleaning, as they can cause damage to both hardware, cables and connectors.

7. DMX Channel

6CH

No.	DMX512 Value	Function
1	0~255	dimmer
2	0~255	Red dimmer
3	0~255	Green dimmer
4	0~255	Blue dimmer
5	0~255	White dimmer
6	0~255	Amber dimmer
7	0~255	UV dimmer
8	0~255	Strobe
9	0~255	Color

10CH

No.	DMX512 Value	Function
1	0~255	dimmer
2	0~255	Red dimmer
3	0~255	Green dimmer
4	0~255	Blue dimmer
5	0~255	White dimmer
6	0~255	Amber dimmer
7	0~255	UV dimmer
8	0~255	Strobe
9	0~255	Auto
10	0~255	Auto Speed

8. Control menu

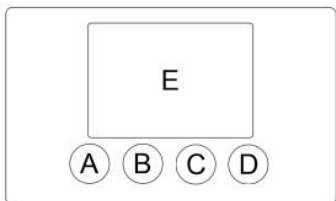

Display:

MENU	To return back to the previous menu
DOWN	To go backward in the selected functions
UP	To go forward in the selected functions
ENTER	To confirm the selected functions

Menu

DMX Setting	Channel DMX address Channel List	6/10CH 001-512 Unpair
setting	Display sleep Dimmer Mode Button Lock Lost DMX Reset	Open/10Sec/20Sec/30Sec Liner / Square / Log On / Off (pass word: up-down-up-down-enter) Clear / Hold Yes / No

Manual Control	Manual Dimming Static Colour Auto Timer Clear RGBWAUV User Colors User Run	RGBWAUV dimming / Strobe (Strobe Speed) C1 - C36 Jump / Fade / Pulse / Combined Start / End / Function / Timer (On/Off) Yes/No Static color / Auto mode
----------------	--	---

Information	Work Time: Temperature Version RDM UID	000H-999H 30°C-70°C Version 1.0
-------------	---	---------------------------------------

9. Specification

Light Source:

AC90-240V, 50/60HZ

12x15 high-power RGBWAUV 6IN1

LEDs 50,000 hours expected lifetime

25° lens beam

Control:

0-100% 32bit linear dimming

1-20 times/second strobe

6/10 Channel DMX

4 built in auto mode

Construction:

IP65 Cast aluminum body

IP65 Seetronic powercon in and out

IP65 seetronic 5-pin DMX in and out

Single holder with OMEGA quick lock

Function:

DMX hold on/off

Can edit colors on the lights directly

Built-in macro color

10. Photometrics

High power setting:

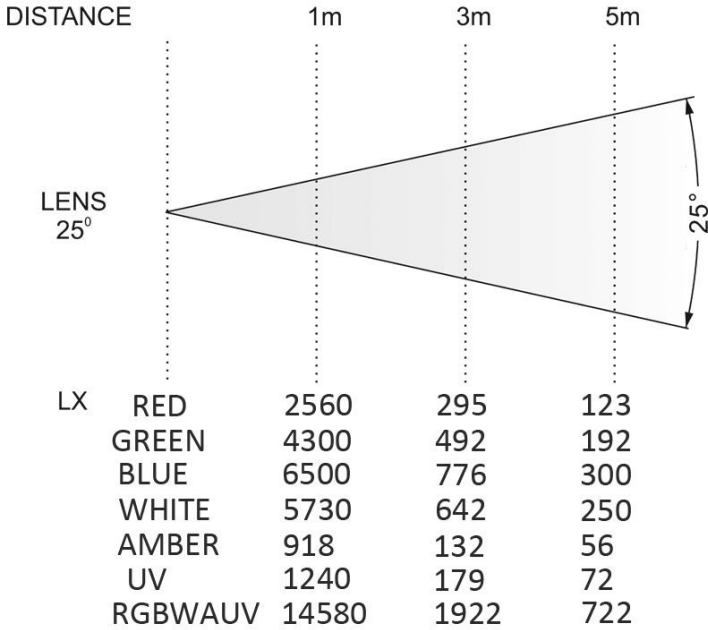

Normal power setting:

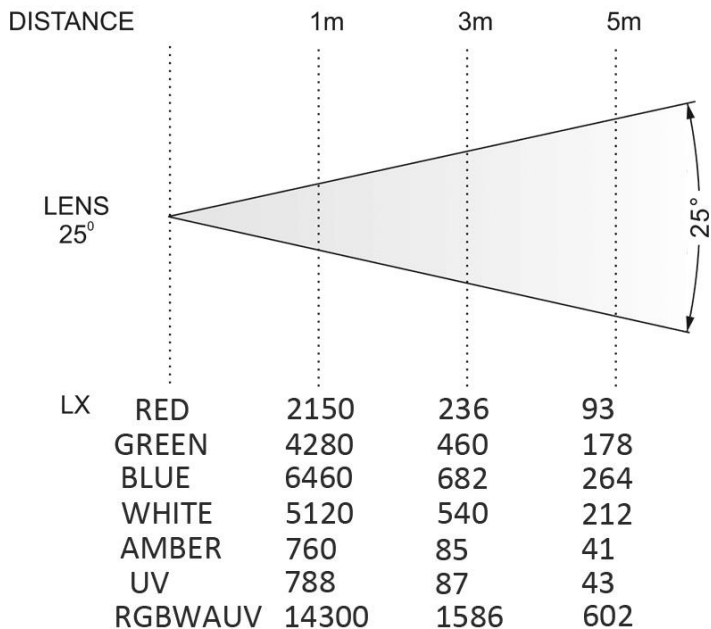

11.Reminder

1. Before using the lights, be better “Reset ” it first : “System Settings” - “Reset” - “Yes”.
2. When on “DMX Address ” page, the lights are in “ Slave ” automatically.

Model: EASY-PL1215

PLUS*lite*

Voltage:	90V ~ 240V/50~60Hz
LEDs:	12x15W RGBWAUV 6IN1 LEDs
IP Rating:	IP65
Beam Angle:	25°
Power Consumption:	130W
Control:	Linear dimming, Strobe, DMX
DMX	6/10 CH
Body:	Aluminium, TFT display 4 touch button
IN&OUT:	IP65 Powercon and 5pin DMX
Weight:	5 Kgs.
Dimensions:	257 x 296 x 259mm
Warranty:	1 Years

Please Note: Specifications and improvements in the design of this unit and this manual are subject to change without any prior written notice

PLUS*lite*

<https://www.pluslite.eu/easy>